

Special Shape Optics

By using the special fabricating method, CNC grinding and polishing machines, Foctek offers the custom-made special shape optics.



Fabricating Specifications

Attribute		Specification
Material		All kinds of high quality optical glass, N-BK7, H-K9L, Fused Silica etc.
Dimension Tolerance (mm)		±0.15 (General), ±0.05 (High Precision)
Angle Tolerance		±0.2 deg. (General), ±10 arc sec. (High Precision)
Surface Quality		60/40 (General), 20/10 (High Precision)
N	For Flat Surface	1 (General), 0.2 (High Precision)
	For Spheric Surface	8 (General), 2 (High Precision)
ΔN	For Flat Surface	0.5 (General), 0.1 (High Precision)
	For Spheric Surface	2 (General), 0.5 (High Precision)

Optical Cemented Components

Foctek designs and manufactures high quality and precision optical cemented components to customers. Special cementing technology, unique adhesive systems, advanced production and inspection facility are our main advantages of making optical cemented components. Foctek's cemented components are manufactured keeping in mind many of the cementing problems that are prevalent in the optical industry.

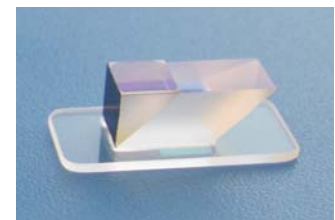
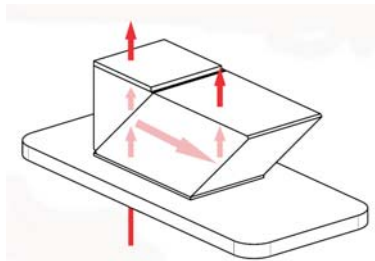
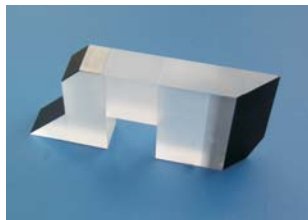

Fabricating Specifications

Attribute	Specification
Material	All kinds of high quality optical glass, like N-BK7, H-K9L, N-SF11 etc.
Dimension Tolerance (mm)	± 0.2 (General), ±0.05 (High Precision)
Beam Deviation	3' (General), 3" (High Precision)
Angle Tolerance	±0.2 deg. (General), ±10 arc sec. (High Precision)
Surface Quality	60/40 (General), 20/10 (High Precision)

Note: FOCtek provides a wide variety of Optical Cemented Components upon request

PART 2

OPTICAL ASSEMBLY





Optical Assemblies

Foctek has strong capabilities in Optical Design, Mechanical Design and Optical Assembly. With integrated optical and mechanical design, fabrication, assembly, advanced metrology, more than 10 years' optical cementing experiences and 6 years' optical assembly experiences, Foctek is not only providing the advanced optical assemblies according to customer's design, but also provide the design services for our customer.

Optical Assemblies	Illustration
<p>Lenses Assemblies</p>	
<p>Precision Optics Assemblies (Prisms, Windows, filters, Beamsplitters, etc.)</p>	
<p>CCTV Lenses</p> 	
<p>Machine Vision Lenses</p> 	
<p>Automotive Camera Lenses</p>	

Continue >>>

ODM, OEM

- ◆ Optical Assembly Design And Manufacture service
- ◆ Optical Lens Design Service
- ◆ Custom-Made Lens

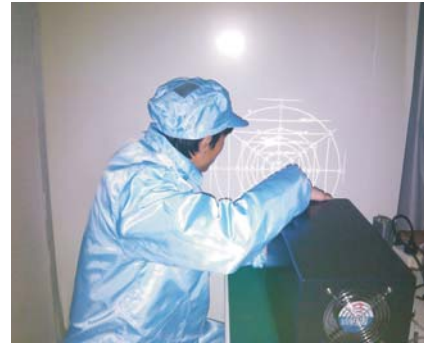
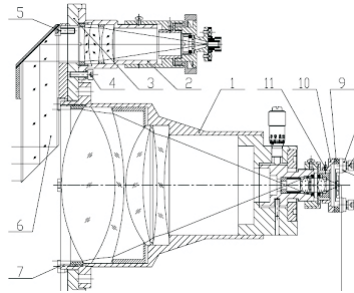

Trioptics ImageMaster MTF Measurer

- Full FOV MTF measuring
- Range: 450-950nm
- EFL, FFL measuring
- Distortion measuring
- Field Curvature measuring
- Astigmatism measuring
- Chromatic Aberration measuring



**Trioptics ImageMaster
MTF Measurer**

Notes:

1. Refer to "Neusion Lens" Catalog for Standard CCTV Lenses & Machine Vision Lenses.
2. Refer to "Automotive Camera Lenses" Catalog for Automotive Camera Lenses.
3. Visit www.neusion-lens.com for CCTV Lenses & Machine Vision Lenses, Automotive Camera Lenses.

PART 3

POLARIZATION OPTICS

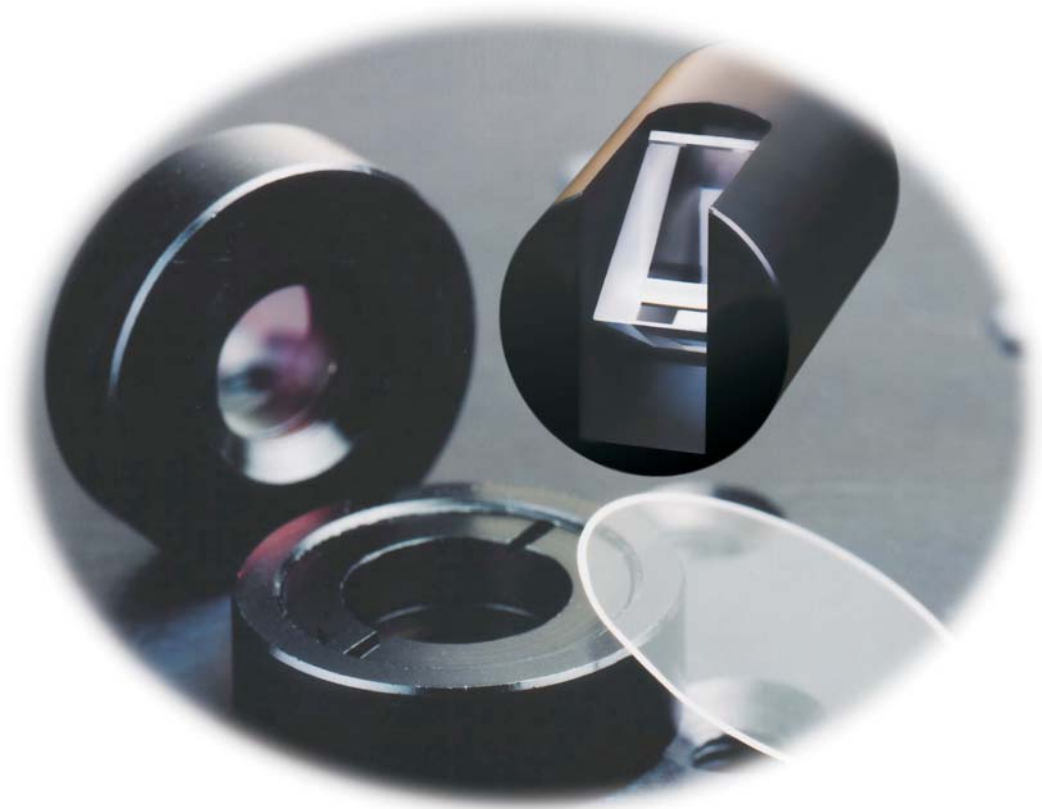

Birefringent Crystals Material

FOCtek manufactures a wide range of polarization optics, include Polarizer (Glan Taylor, Glan Laser, Glan Thompson, Wollaston and Rochon), polarization beam combiner, waveplate, polarization rotator, Depolarizer by adopting Birefringent crystals of α -BBO, calcite, YVO_4 , quartz and MgF_2 .

α -BBO is characterized by large birefringent coefficient and wide transmission window from 189nm to 3500nm, particularly suitable for high power UV polarizer (200-300nm). But, its high hygroscopic susceptibility increases the difficulty of fabricating.

Calcite is a natural minded crystal and the most common crystals for polarizers used as visible and near IR polarizers. Defects of natural minded crystal, such as bubbles, striae, optical inhomogeneity and stress birefringence, cause degradation of polarization and transmission loss. That is why the extinction of the polarizer is not as high as synthetically grown material YVO_4 , α -BBO.

YVO_4 crystal has been widely used in fiber optical components due to its large birefringence, good physical and favorable mechanical properties. Since the crystal has high transmission from 500 to 3500 nm, it is recommended to use YVO_4 polarizer for IR application.

Crystal Quartz has optical activity, It rotates the polarization plane of linearly polarized beam when the beam travel along the crystal optic axis. Because of its low birefringence, it is not feasible to fabricate Glan type polarizer, but suitable for Rochon or wollaston. And it is a excellent material for waveplate.

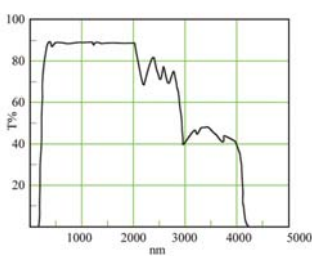

α -BBO: T% vs Wavelength

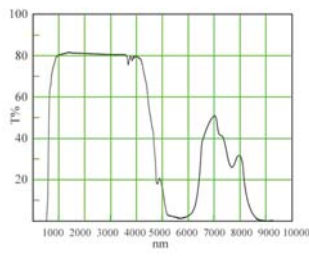

YVO_4 : T% vs Wavelength

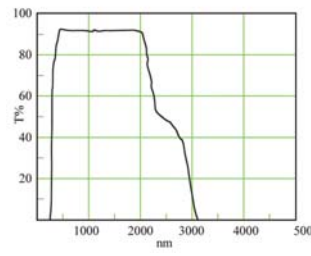

Calcite: T% vs Wavelength

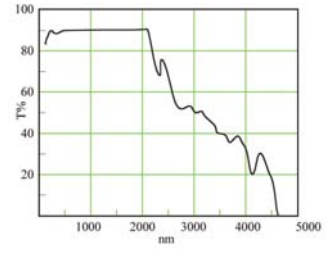

Quartz: T% vs Wavelength

MgF_2 Crystal has very wide transmission range from 110 nm to 8500nm. It is the best material for DUV application. Same reason of its low birefringence, MgF_2 is not feasible to fabricate Glan type polarizer, but suitable for Rochon or wollaston. MgF_2 is also used for waveplate, and commonly works together with quartz to make achromatic waveplate

Comparison of main properties of the materials listed below:

	YVO_4	Calcite	α -BBO	Quartz	MgF_2
Transparency	400-5000nm	350-2300nm	189-3500nm	200-2300nm	110-8500nm
Crystal Class(Uniaxial)	Positive $n_o = n_a = n_b, n_e = n_c$	Negative $n_o = n_a = n_b, n_e = n_c$	Negative $n_o = n_a = n_b, n_e = n_c$	Positive $n_o = n_a = n_b, n_e = n_c$	Positive $n_o = n_a = n_b, n_e = n_c$
Mohs Hardness	5	3	4.5	7	6
Thermal Expansion Coefficient	$\alpha_a = 4.43 \times 10^{-6}/k$ $\alpha_e = 11.37 \times 10^{-6}/k$	$\alpha_a = 24.39 \times 10^{-6}/k$ $\alpha_e = 5.68 \times 10^{-6}/k$	$\alpha_a = 4 \times 10^{-6}/k$ $\alpha_e = 36 \times 10^{-6}/k$	$\alpha_a = 6.2 \times 10^{-6}/k$ $\alpha_e = 10.7 \times 10^{-6}/k$	$\alpha_a = 9.5 \times 10^{-6}/k$ $\alpha_e = 14.3 \times 10^{-6}/k$
Hygroscopic Susceptibility	NO Hygroscopic	Low to Moisture	High	NO Hygroscopic	NO Hygroscopic
Refractive Index(633nm)	$n_o = 1.9928$ $n_e = 2.2153$	$n_o = 1.6558$ $n_e = 1.4852$	$n_o = 1.6706$ $n_e = 1.5483$	$n_o = 1.5427$ $n_e = 1.5518$	$n_o = 1.37698$ $n_e = 1.38876$

Polarizer

A polarizer is an important optical component that is widely used in laser systems to generate the linear polarization laser. Foctek makes following polarizers with five materials, α -BBO, Calcite and YVO_4 , Quartz MgF_2 , suitable for the widest spectrum and high polarization purity applications.

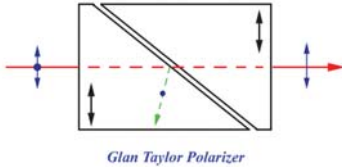
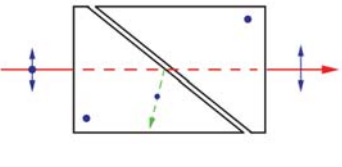
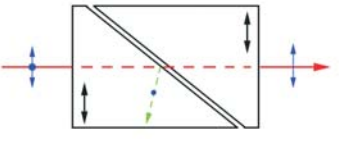
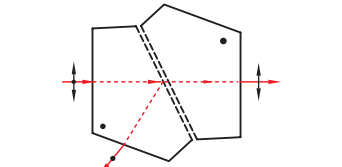
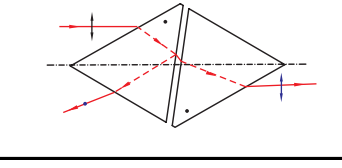
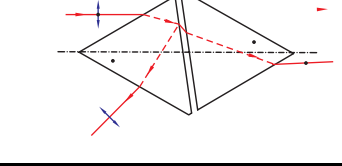
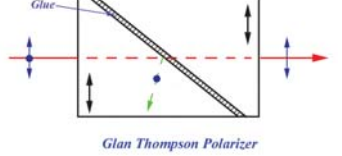
Polarizer	Material	Illustration	Properties and Application
Glan-Taylor Polarizer	α -BBO (200-3500nm) Calcite (350-2300nm)	 <i>Glan Taylor Polarizer</i>	<ul style="list-style-type: none"> ♦ Air Spaced ♦ Close to Brewster's Angle Cutting ♦ Low L/A ♦ Mounted without escape windows ♦ For low to medium power application
	YVO_4 (400-5000nm)		
Glan-Laser Polarizer	α -BBO (200-3500nm) Calcite (350-2300nm)		<ul style="list-style-type: none"> ♦ Air Spaced ♦ Close to Brewster's Angle Cutting ♦ Mounted with escape windows ♦ Suitable for high power application ♦ Low L/A
	YVO_4 (400-5000nm)		
High Transmission Glan-Laser Polarizer	YVO_4 (400-5000nm)		<ul style="list-style-type: none"> ♦ Air Spaced ♦ Brewster's Angle Cutting ♦ Mounted with escape windows ♦ Suitable for high power and high transmission application ♦ Brewster Angle input
	Calcite (350-2300nm)		
Glan Thompson Polarizer	α -BBO (220-1100nm) (200-3300nm) Calcite (350-2300nm)	 <i>Glan Thompson Polarizer</i>	<ul style="list-style-type: none"> ♦ Cemented ♦ Suitable for low power application ♦ Wide acceptance angle field

Polarizer	Material	Illustration	Properties and Application
Glan Thompson Polarizing Beamsplitter Cube	Calcite (350-2300nm)	<p>Glan Thompson Polarizing Beamsplitter Cubes</p>	<ul style="list-style-type: none"> ◆Cemented ◆Suitable for low power application ◆Wide acceptance angle field ◆Split o-ray & e-ray at 45° or 90° ◆Also can work as polarization Beam combiner
Wollaston Polarizer	YVO4 (400-5000nm) Quartz(200-2300nm) MgF2(130-6000nm)	<p>Wollaston Polarizer</p>	<ul style="list-style-type: none"> ◆Cemented ◆Separate ordinary and extraordinary beams at certain angle ◆Suitable for low power application and where the large deviation is required
	α -BBO(200-3500nm) Calcite(350-2300nm)	<p>Wollaston Polarizer</p>	
Rochon Polarizer	α -BBO(200-3500nm)		<ul style="list-style-type: none"> ◆α-BBO is used to guarantee a wide transmission range ◆Especially, suitable for UV application ◆Split the ordinary and extraordinary ray, but only ordinary beam is deviated
	YVO4 (400-5000nm) MgF2 (130-6000nm) Quartz (200-2300nm)		
BroadBand Polarization Combiner	YVO4 (400-5000nm)		<ul style="list-style-type: none"> ◆Air Spaced ◆For High power Application ◆Broad Band From 500-5000nm
Polarization Beamsplitter	N-BK7 Grade A Optical Glass or N-SF ₂ Optical Glass		<ul style="list-style-type: none"> ◆Split the ordinary and extraordinary ray. The ordinary beam is deviated 90° Refer to chapter "Beamsplitter" for detailed information

Glan Taylor Polarizer

Glan Taylor polarizer is made of two same birefringent material prisms that are assembled with an air space. It has a length to aperture ratio less than 1.0 makes it a relatively thin polarizer. The polarizer with no side escape windows are suitable for low to medium power application where the side rejected beams are not required, which is suitable for a wide variety of applications, particularly with collimated input beams. The angular field of different materials of polarizers listed below for comparison. (Fo for o-ray; Fe for e-ray)

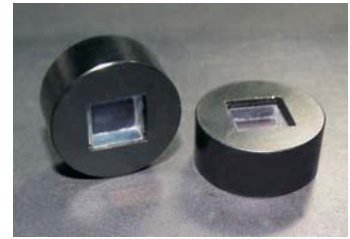

Angular Field vs wavelength

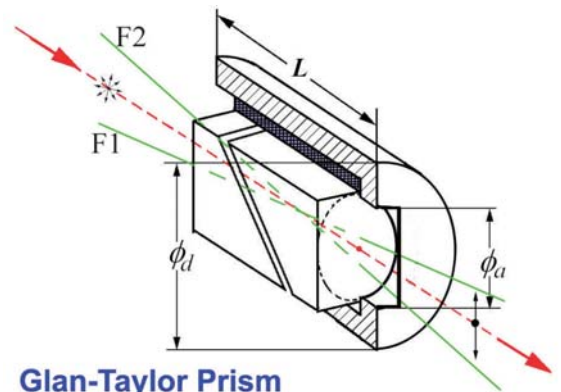
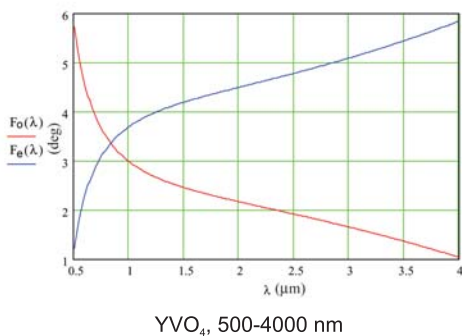
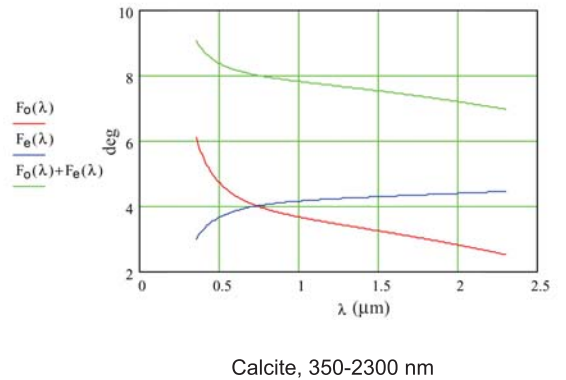
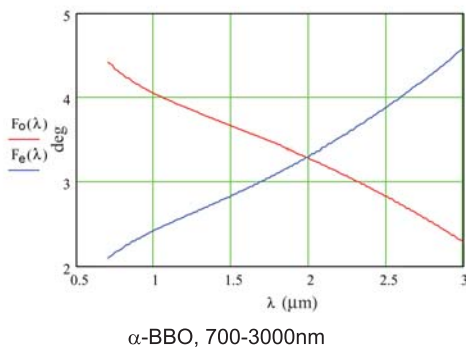
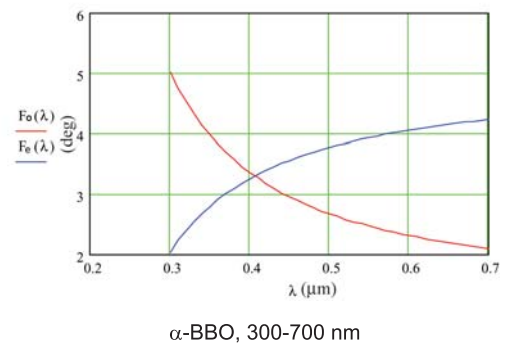
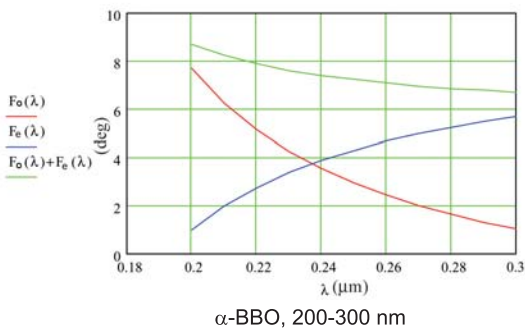

Features:

- Air-spaced
- Close to Brewster's Angle Cutting.
- High Polarization Purity.
- Short Length.
- Suitable for low to medium power application where the rejected beam is not required.

Specifications:

Material	:	a-BBO, Calcite or YVO ₄
Wavelength Range	:	α-BBO: 200-3500 nm, Calcite: 350-2300 nm YVO₄: 400-5000 nm
Extinction Ratio	:	Calcite: <5x10 ⁻⁵ ; α-BBO: <5x10 ⁻⁶ ; YVO₄: <5x10 ⁻⁶
Surface Quality	:	20-10
Beam Deviation	:	< 3 arc minutes
Flatness	:	λ/4@633nm
Damage Threshold	:	>200 MW/cm ²
Coating	:	Single Layer MgF ₂
Mount	:	Black Anodized Aluminium

Transmission (T%) vs wavelength

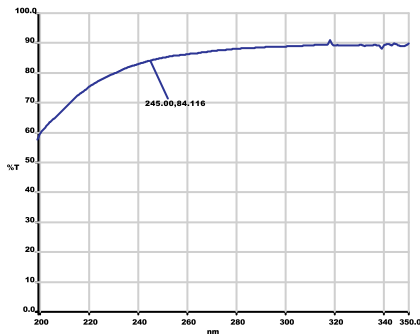

α-BBO 200-270nm (GTP6200)

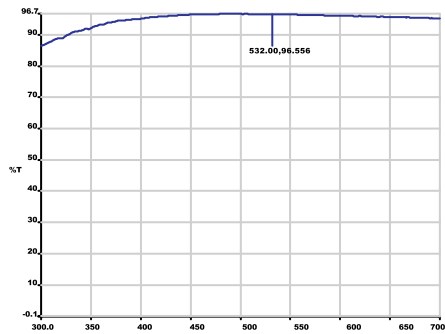

α-BBO 300-700nm (GTP6300)

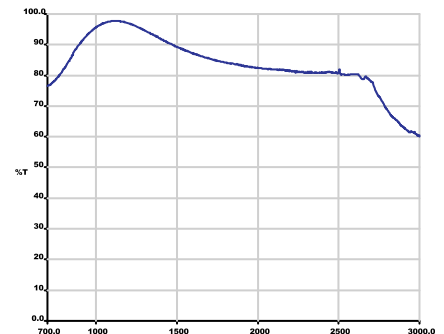

α-BBO 700-3000nm (GTP6700)

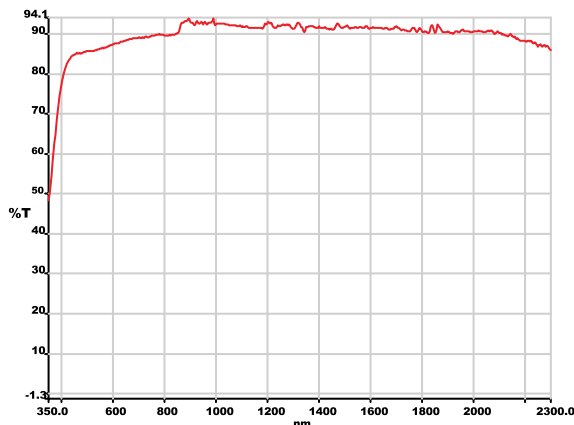

Calcite 350-2300nm

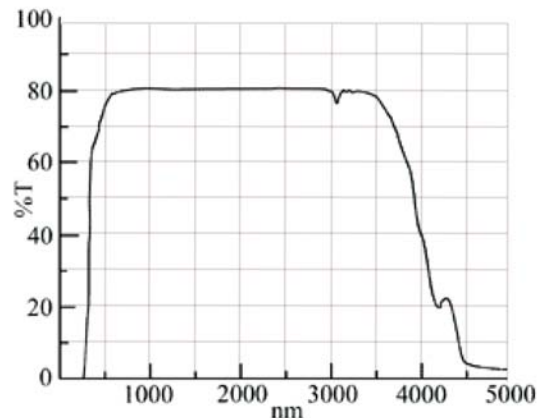

YVO₄ 400-5000nm

Standard Products

1. α -BBO Glan Taylor Polarizer

P/N #	Wavelength Range (nm)	Extinction Ratio	Angular Field (deg)	CA Φ_a (mm)	O.D. Φ_d (mm)	L \pm 0.1 (mm)	Unit Price
GTP6206	200-270 (Single Layer MgF ₂) (Coating@245nm)	<5 x 10 ⁻⁶	>6.0°	5.0	15.0	8.0	\$199.0
GTP6208				7.0	25.4	10.0	\$239.0
GTP6210				9.0	25.4	11.0	\$299.0
GTP6215				13.5	30.0	15.0	\$499.0
GTP6220				18.0	38.0	19.0	\$789.0
GTP6306	300-700 (Single Layer MgF ₂) (Coating@532nm)	<5 x 10 ⁻⁶	>6.0°	5.0	15.0	8.0	\$199.0
GTP6308				7.0	25.4	10.0	\$239.0
GTP6310				9.0	25.4	11.0	\$299.0
GTP6315				13.5	30.0	15.0	\$499.0
GTP6320				18.0	38.0	19.0	\$789.0
GTP6706	700-3000 (Single Layer MgF ₂) (Coating@1064nm)	<5 x 10 ⁻⁶	>6.0°	5.0	15.0	8.0	\$199.0
GTP6708				7.0	25.4	10.0	\$239.0
GTP6710				9.0	25.4	11.0	\$299.0
GTP6715				13.5	30.0	15.0	\$499.0
GTP6720				18.0	38.0	19.0	\$789.0

2. Calcite Glan Taylor Polarizer

P/N #	Wavelength Range (nm)	Extinction Ratio	Angular Field (deg)	CA Φ_a (mm)	O.D. Φ_d (mm)	L \pm 0.1 (mm)	Unit Price
GTP7006	350-2300 (Single Layer MgF ₂) (Coating@1064nm)	<5 x 10 ⁻⁵	>7.7°	5.0	15.0	8.0	\$189.0
GTP7008				7.0	25.4	10.0	\$229.0
GTP7010				9.0	25.4	11.0	\$279.0
GTP7015				13.5	30.0	15.0	\$399.0
GTP7020				18.0	38.0	19.0	\$669.0

3. YVO₄ Glan Taylor Polarizer

P/N #	Wavelength Range (nm)	Extinction Ratio	Angular Field (deg)	CA Φ_a (mm)	O.D. Φ_d (mm)	L \pm 0.1 (mm)	Unit Price
GTP8006	500-4000 (Single Layer MgF ₂) (Coating@1300nm)	<5 x 10 ⁻⁶	>6.5°	5.0	15.0	7.0	\$189.0
GTP8008				7.0	25.4	9.0	\$219.0
GTP8010				9.0	25.4	10.0	\$299.0
GTP8015				13.5	30.0	12.0	\$509.0
GTP8020				18.0	38.0	15.0	\$779.0

Note: Price list is for quantity \leq 5 pcs.

Call for OEM quantity pricing, AR coated and Custom Design Polarizer.

Glan Laser Polarizer

Glan Laser polarizer is made of two same birefringent material prisms that are assembled with an air space. The polarizer is a modification of the Glan Taylor type and is designed to have less reflection loss at the prism junction. The polarizer with two escape windows allow the rejected beam to escape out of the polarizer, which makes it more desirable for high energy lasers. The surface quality of these faces is relatively poor as compared to that of entrance and exit faces. No scratch dig surface quality specifications are assigned to these faces.



Angular Field vs wavelength

Please refer to Page 44 Glan Taylor Polarizer.

Features:

- Air Spaced.
- Close to Brewster's angle Cutting.
- Mounted with escape windows.
- High Polarization purity.
- Suitable for high power applications.

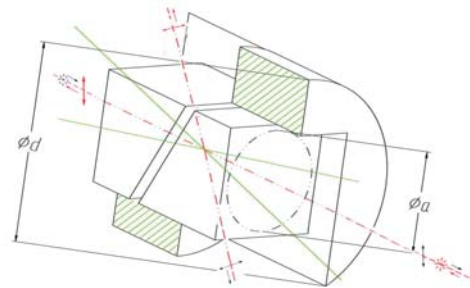

Glan-Laser Prism

Material	:	α -BBO, Calcite or YVO_4
Wavelength Range	:	α -BBO: 200-3500 nm, Calcite: 350-2300 nm YVO_4 : 400-5000 nm
Extinction Ratio	:	Calcite: $<5 \times 10^{-5}$; α -BBO: $<5 \times 10^{-6}$; YVO_4 : $<5 \times 10^{-6}$
Surface quality	:	20-10
Beam Deviation	:	< 3 arc minutes
Flatness	:	$\lambda/4@633nm$
Damage Threshold	:	>500 MW/cm ²
Coating	:	Single Layer MgF ₂
Mount	:	Black Anodized Aluminium

Transmission (T%) vs wavelength

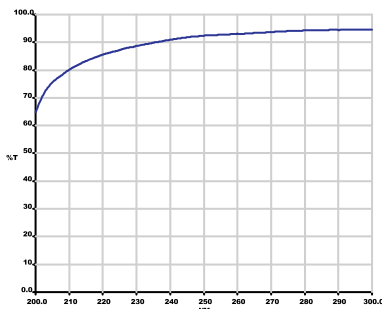

α -BBO: 200-300 nm (GLP 6200)

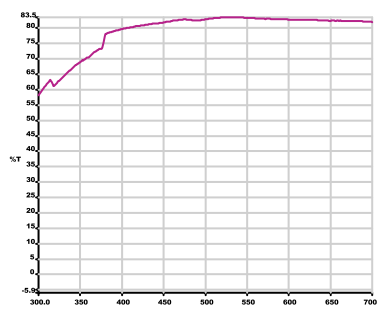

α -BBO: 300-700 nm (GLP6300)

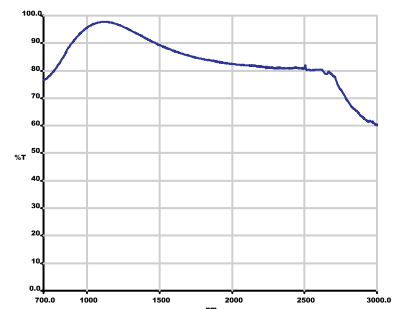

α -BBO: 700-3000 nm (GLP6700)

Standard Products**1. α -BBO Glan Laser Polarizer**

P/N #	Wavelength Range (nm)	Extinction Ratio	Angular Field (deg)	CA Φ_a (mm)	O.D. Φ_d (mm)	L \pm 0.1 (mm)	Unit Price
GLP6206	200-270 (Single Layer MgF ₂) (Coating@245nm)	<5 x 10 ⁻⁶	>6.0°	5.0	15.0	12.0	\$269.0
GLP6208				7.0	25.4	15.0	\$299.0
GLP6210				9.0	25.4	20.0	\$399.0
GLP6215				13.5	30.0	25.0	\$589.0
GLP6220				18.0	38.0	34.0	\$839.0
GLP6306	300-700 (Single Layer MgF ₂) (Coating@532nm)	<5 x 10 ⁻⁶	>6.0°	5.0	15.0	12.0	\$269.0
GLP6308				7.0	25.4	15.0	\$299.0
GLP6310				9.0	25.4	20.0	\$399.0
GLP6315				13.5	30.0	25.0	\$589.0
GLP6320				18.0	38.0	34.0	\$839.0
GLP6706	700-3000 (Single Layer MgF ₂) (Coating@1064nm)	<5 x 10 ⁻⁶	>6.0°	5.0	15.0	12.0	\$269.0
GLP6708				7.0	25.4	15.0	\$299.0
GLP6710				9.0	25.4	20.0	\$399.0
GLP6715				13.5	30.0	25.0	\$589.0
GLP6720				18.0	38.0	34.0	\$839.0

2. Calcite Glan Laser Polarizer

P/N #	Wavelength Range (nm)	Extinction Ratio	Angular Field (deg)	CA Φ_a (mm)	O.D. Φ_d (mm)	L \pm 0.1 (mm)	Unit Price
GLP7006	350-2300 (Single Layer MgF ₂) (Coating@1064nm)	<5 x 10 ⁻⁵	>7.7°	5.0	15.0	12.0	\$199.0
GLP7008				7.0	25.4	15.0	\$219.0
GLP7010				9.0	25.4	20.0	\$269.0
GLP7015				13.5	30.0	25.0	\$429.0
GLP7020				18.0	38.0	34.0	\$699.0

3. YVO₄ Glan Laser Polarizer

P/N #	Wavelength Range (nm)	Extinction Ratio	Angular Field (deg)	CA Φ_a (mm)	O.D. Φ_d (mm)	L \pm 0.1 (mm)	Unit Price
GLP8006	400-5000 (Single Layer MgF ₂) (Coating@1300nm)	<5 x 10 ⁻⁶	>6.5°	5.0	15.0	15.5	\$238.0
GLP8008				7.0	25.4	19.0	\$319.0
GLP8010				9.0	25.4	22.5	\$369.0
GLP8015				13.5	30.0	31.0	\$619.0

Note: Price list is for quantity \leq 5 pcs.

Call for OEM quantity pricing, AR coated and Custom Design Polarizer.

A wide variety of custom design GLAN Laser Polarizer are available upon request

Custom Size Mount is available upon request

AR coated Polarizer is available upon request

High Transmisson Glan Laser Polarizer

Foctek specially designed a high transmission Glan Laser Polarizer for application which requires high transmission. The specially designed polarizer is based on the Brewster Cut crystal, which can improve the transmission from normally >85% to 95%. This polarizer can be made from both Calcite and YVO₄.



Features:

- Air Spaced.
- All Brewster's angle Cutting.
- Mounted with escape windows.
- High Polarization purity.
- Suitable for high power applications.
- High transmission.
- Brewster angle input.

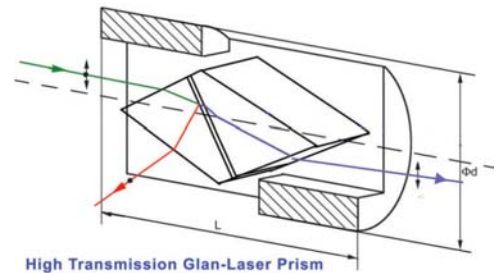

Specifications:

Material	:	Calcite or YVO ₄
Wavelength Range	:	Calcite: 350-2300 nm, YVO₄: 400-5000 nm
Extinction Ratio	:	Calcite:<5x10 ⁻⁵ ; YVO ₄ :<5x10 ⁻⁶
Surface quality	:	20-10
Beam Deviation	:	< 3 arc minutes
Flatness	:	λ/4@633nm
Damage Threshold	:	>500 MW/cm ²
Coating	:	Uncoated
Transmission	:	>95%
Mount	:	Black Anodized Aluminium

Standard Products

1. Calcite High Transmission Glan Laser Polarizer

P/N #	Wavelength Range (nm)	Extinction Ratio	CA Φa (mm)	O.D. Φd (mm)	L+/-0.1 (mm)
GLH7006	350-2300	<5 x 10 ⁻⁵	5.0	25.4	11.3
GLH7008			7.0	25.4	14.8
GLH7010			9.0	25.4	18.4

2. YVO₄ High Transmission Glan Laser Polarizer

P/N #	Wavelength Range (nm)	Extinction Ratio	CA Φa (mm)	O.D. Φd (mm)	L+/-0.1 (mm)
GLH8006	400-5000	<5 x 10 ⁻⁶	5.0	25.4	13.2
GLH8008			7.0	25.4	17.6
GLH8010			9.0	25.4	22.0

Note: Call for pricing and Custom Design Polarizer.

Glan Thompson Polarizer

Glan Thompson polarizer is made of two calcite prisms or α -BBO prisms cemented together. Two types of Glan Thompsons are available. One is the standard form and the other is the long form. Their length to aperture ratios are 2.5 : 1 and 3.0 : 1 respectively. Glan Thompsons tend to have higher extinction ratio than air spaced polarizers. In the ultra violet spectrum, their transmission is limited by absorption in birefringent materials as well as the cement layer. α -BBO polarizers and Calcite polarizers can be used from about 200 to 900nm and 350 to 2300 nm respectively.

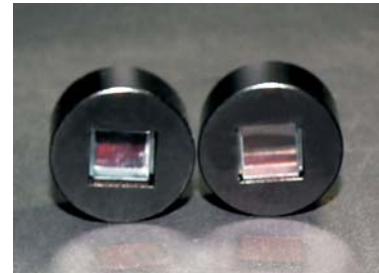

The polarizers have the widest field angle of any design. The standard form of this polarizer with 2.5:1 length to aperture ratio has a full acceptance cone angle of more than 15° @ 589nm, symmetric about the input axis, while the long form with 3:1 ratio has a field angle >26°. The polarized field Angle Fo and Fe of all these is shown in the plot below.

Angular Field vs wavelength

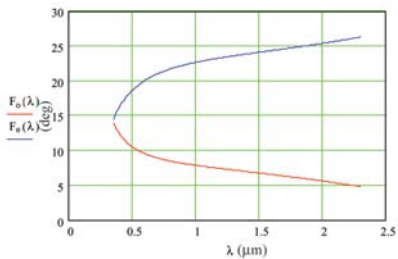

Calcite: L/A=2.5 (350-2300nm)

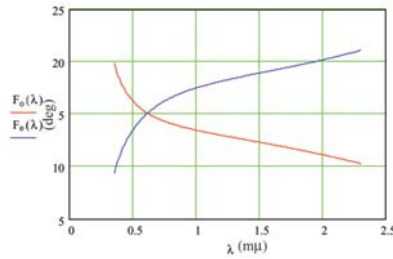

Calcite: L/A=3.0 (350-2300nm)

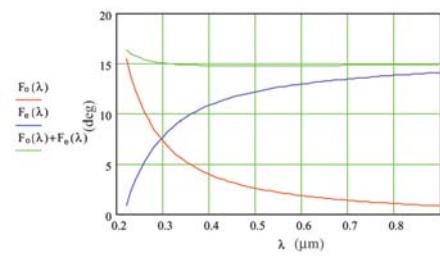

α -BBO: 200-900 nm

Specifications:

- Material : α -BBO, Calcite
- Wavelength Range : **α -BBO:** 200-1100 nm, **Calcite:** 350-2300 nm
- Extinction Ratio : Calcite: $<5 \times 10^{-5}$; α -BBO: $<5 \times 10^{-6}$
- Surface quality : 20-10
- Beam Deviation : < 3 arc minutes
- Flatness : $\lambda/4 @ 633\text{nm}$
- Damage Threshold : $>200 \text{ MW/cm}^2$
- Coating : Single Layer MgF₂
- Mount : Black Anodized Aluminium

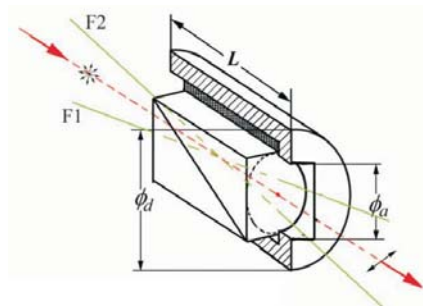

Glan-Thompson Prism

Transmission (T%) vs wavelength

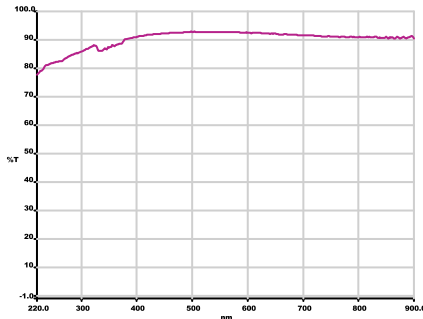

GMP 6010

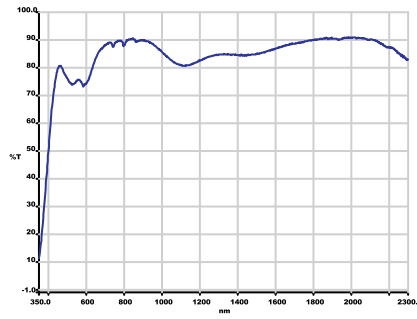

GMP 7110

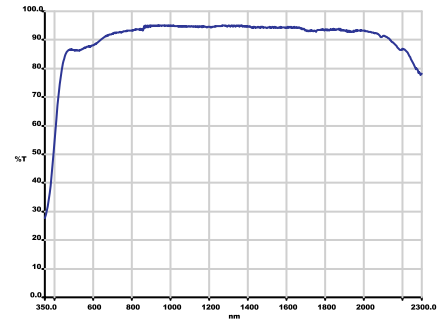

GMP 7215

1. α-BBO Glan Thompson Polarizer (Foctek Patent NO.: ZL 2005 1 0018753.6)

P/N #	Wavelength Range(nm)	L/CA	Extinction Ratio	Angular Field (deg)	CA Φa (mm)	O.D. Φd (mm)	L+/-0.1 (mm)	Unit Price
GMP6006	200-1100 (Single Layer MgF2) (Coating@532nm)	1.6	<5 x 10 ⁻⁶	>15°	5.0	15.0	14.0	\$299.0
GMP6008					7.0	25.4	17.0	\$359.0
GMP6010					9.0	25.4	21.0	\$479.0
GMP6012					11.4	25.4	26.0	\$599.0
GMP6015					13.5	30.0	31.0	\$749.0
GMP6020					18.0	38.0	40.0	\$989.0

2. Calcite Glan Thompson Polarizer

P/N #	L/CA	Extinction Ratio	Angular Field (deg)	CA Φa (mm)	O.D. Φd (mm)	L+/-0.1 (mm)	Unit Price
GMP7106	2.5	<5 x 10 ⁻⁵	14°-16°	5.0	15.0	18.0	\$229.0
GMP7108				7.0	25.4	23.0	\$259.0
GMP7110				9.0	25.4	28.0	\$315.0
GMP7112				11.4	25.4	35.0	\$389.0
GMP7115				13.5	30.0	41.0	\$426.0
GMP7206	3.0	<5 x 10 ⁻⁵	25°-28°	5.0	15.0	21.0	\$289.0
GMP7208				7.0	25.4	27.0	\$329.0
GMP7210				9.0	25.4	33.0	\$399.0
GMP7212				11.4	25.4	41.0	\$469.0
GMP7215				13.5	30.0	48.0	\$569.0

Note: Price list is for quantity ≤5 pcs.

Call for OEM quantity pricing, AR coated and Custom Design Polarizer.