

MDL-III-415/1~100mW



VIOLET DIODE LASER
AT 415nm

It features ultra compact design, long lifetime, cost-effectiveness and easy operation. They are used in measurement, communication, spectrum analysis, etc.



SPECIFICATIONS

Central wavelength (nm)	415±5	
Operating mode	CW	
Output power (mW)	>1, 10, 20, ..., 100	
Power stability (rms, over 4 hours)	<1%, <2%, <3% (<0.5%, optional)	
Transverse mode	Near TEM ₀₀	
M ² factor	<1.5 (<1.2, optional)	
Beam diameter at the aperture (1/e ² ,mm)	~3.5 (~1.2, optional)	
Beam divergence, full angle (mrad)	<1.0	
Polarization ratio	>50:1 (>100:1, optional) Horizontal±5 degree (Vertical Optional)	
Warm-up time (minutes)	<5	
Pointing stability after warm-up (mrad)	<0.05	
Beam height from base plate (mm)	24.8	
Operating temperature (°C)	10~35	
Power supply	85-264VAC	PSU-III-LED/ PSU-III-FDA (Frequency for 1Hz-30kHz)
	100-240VAC	PSU-A-D (Frequency for 30kHz -100kHz)
TTL / Analog modulation	TTL or Analog with 1Hz-1kHz 1kHz-10kHz, 10kHz-30kHz, 30kHz-100kHz optional	
Expected lifetime (hours)	10000	
Warranty	1 year	

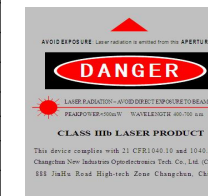

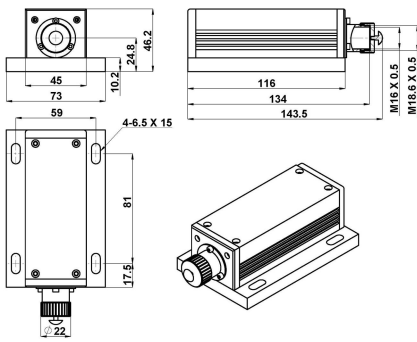
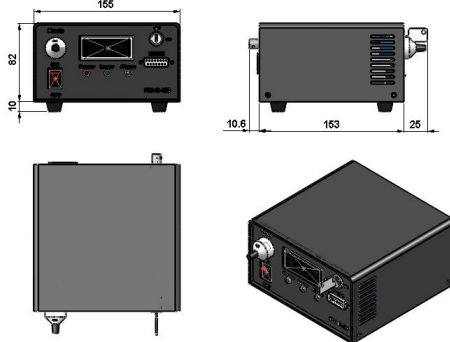
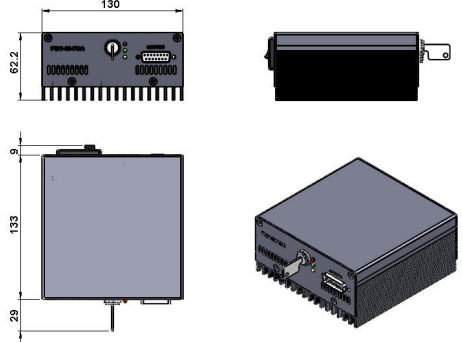
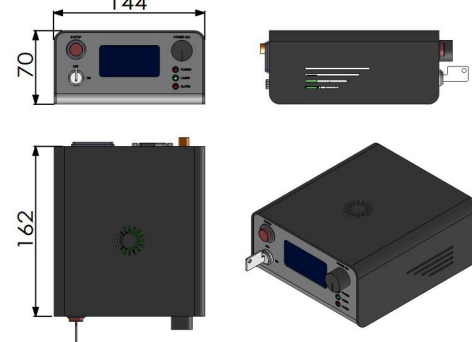
MDL-III-415	PSU-III-LED	PSU-III-FDA	PSU-A-D
 <p>143.5(L)×73(W)×46.2(H) mm³, 0.7kg</p>	 <p>188.6 (L) ×155(W) ×92 (H) mm³, 1.5kg</p>	 <p>171(L) ×130(W) ×62.2 (H) mm³, 1.2kg</p>	 <p>162(L) ×144(W) ×70 (H) mm³, 1.0kg</p>