

MIL-V-1047/ 2~8W

### LD PUMPED ALL-SOLID-STATE INFRARED LASER AT 1047 nm

All solid state infrared laser at 1047nm is made features of ultra compact, low cost and easy operating, which is used in scientific experiment, optical instrument, optical sensor, measurement, communication, spectrum analysis, etc.



#### SPECIFICATIONS

Wavelength (nm)	1047±1
Operating mode	CW
Output power (W)	> 2, 3, ..., 8
Power stability (rms, over 4 hours)	<1%, <2%, <3%
Transverse mode	Near TEM <sub>00</sub>
Warm-up time (minutes)	<10
M <sup>2</sup> factor	<2.0
Beam divergence, full angle (mrad)	<2.0
Beam diameter at the aperture (1/e <sup>2</sup> , mm)	~3.0
Beam height from base plate (mm)	113
Polarization ratio	>100:1
Pointing stability after warm-up (mrad)	<0.05
Cooled method	Air cooled
Operating temperature (°C)	10~35
Power supply (90-264VAC)	PSU-AOM (3U)
Expected lifetime (hours)	10000
Warranty period	1 year

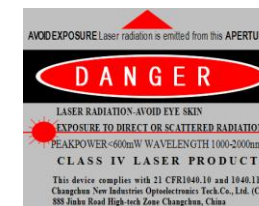

MIL-V-1047

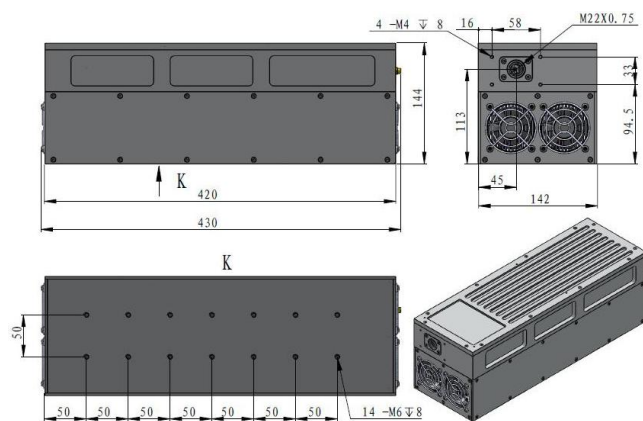

420 (L) × 142 (W) × 144 (H) mm<sup>3</sup>, 9.5 kg

PSU-AOM(3U)

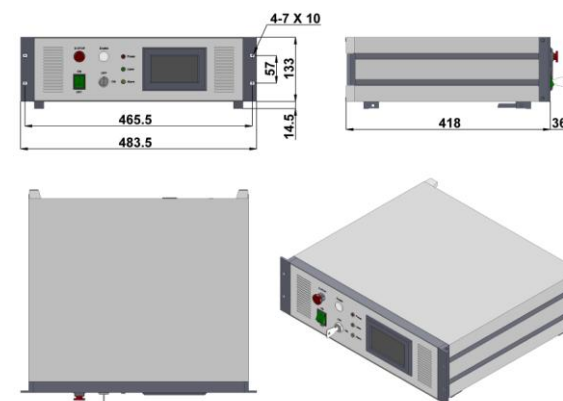

483.5 (L) × 454 (W) × 147.5 (H) mm<sup>3</sup>, 8.3 kg