

MSL-III-830L/1~80mW

SPECIFICATIONS



**SINGLE LONGITUDINAL
MODE INFRARED DIODE
LASER AT 830nm**

It features ultra compact design, long lifetime, cost-effectiveness and easy operation. They are used in Raman spectroscopy, speckle interferometry, bio-instrumentation, metrology, sensing, analytical instrumentation.



Central wavelength (nm)	830±1
Operating mode	CW
Output power (mW)	> 10, 20, ..., 80
Power stability (rms, over 4 hours)	<1%, <2%, <3%
Transverse mode	Near TEM ₀₀
Longitudinal mode	Single
Spectral linewidth (MHz)	<50
Coherent length (m)	>2
M ² factor	<1.5
Beam diameter at the aperture (1/e ² ,mm)	<3
Beam divergence, full angle (mrad)	<1.2
Polarization ratio	>50:1 (>100:1, optional) Horizontal±5 degree (Vertical Optional)
Warm-up time (minutes)	<5
Beam height from base plate (mm)	24.8
Operating temperature (°C)	10~35
Power supply (85-264VAC)	PSU-III-FDA
Expected lifetime (hours)	10000
Warranty	1 year



MSL-III-830L

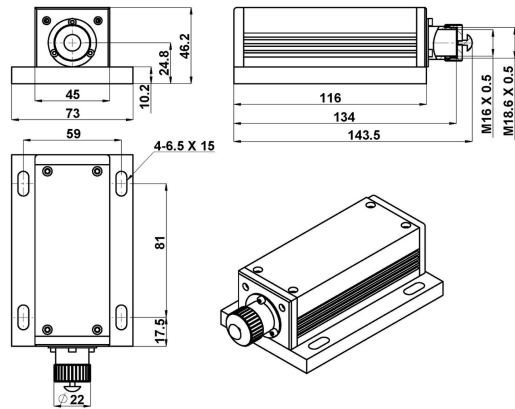

143.5(L)×73(W)×46.2(H) mm³, 0.7kg

PSU-III-FDA

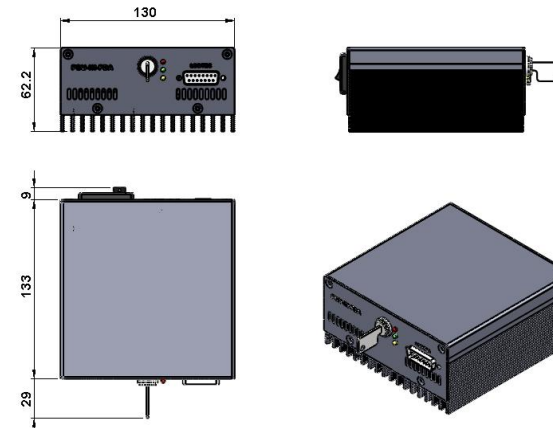

171(L)×130(W)×62.2(H) mm³, 1.2kg